

Brass Ball Valves

10kgf/cm³ Forged brass Ball Valve (KS B 2308)

 Korean Standar (KS) Approved Product

Specification

Working Pressure	Max Pressure	Size	Max Temperature	Thread spec
0.98MPa(10kgf/cm ²)	1.37MPa(14kgf/cm ²)	8A~100A	below 80°C	KS B 0222

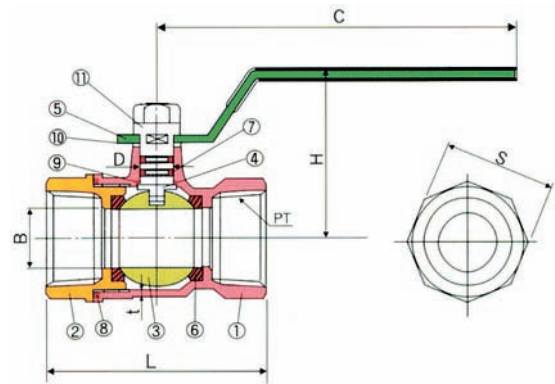

Part Description

NO	Parts Name	Material Spec	NO	Parts Name	Material Spec
1	Body	C3771 BD-F / YBSC3	7	O-Ring	NBR
2	Cap	C3771 BD-F	8	Seal Ring	NBR
3	Ball	C3604 BD-F / C3771 BD-F	9	Back Packing	PTFE
4	Stem	C3604 BD	10	Handle Parking	PTFE
5	Handle	SS 330	11	Flange Nut	SWRM 8
6	Seat ring	PTFE			

Dimension

Model NO	L	H	S	t(Min.)	D(Min.)	B
8A	42.8	33.5	18	2	7	8
10A	44.5	33.5	20	2.3	7	8
15A	52.7	43.5	26	2.8	8	10
20A	54	46	31	2.3	9	15
25A	64.5	56.5	38	2.3	11	20
32A	78	61.5	47	2.8	11	25
40A	84.5	68.5	54	3.3	13	32
50A	98	74.5	67	4.3	15	40
65A	129	87	84	3.5	18	50
80A	146	100	99	4.4	18	65
100A	192	106	122	4.5	18	80



Stainless Steel Ball Valves

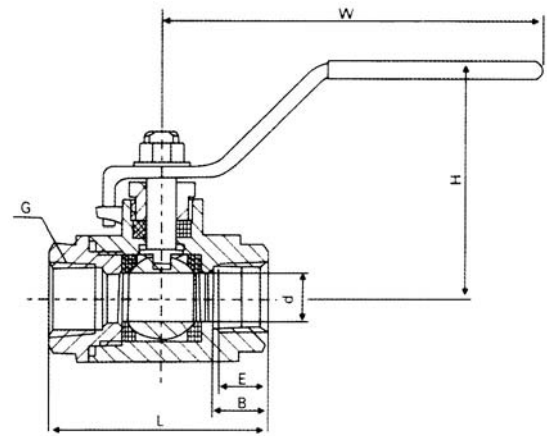

NO	Parts Name	Material Spec
1	Body	CF8
2	Cap	CF8
3	Ball	SS304
4	Seat	RPTFE
5	Stem	SS304
6	Handle	SS304
7	Packing	PTFE
8	Gasket	PTFE
9	Nut	SS304
10	Handle Cover	PLASTIC
11	Washer	SS304

DN	Size	Φd	L	H	W
8A	1/4"	8	55	42	95
10A	3/8"	10	55	42	95
15A	1/2"	15	62	51	108
20A	3/4"	20	75	58	115
25A	1"	25	85	77	135
32A	1-1/4"	32	102	83	150
40A	1-1/2"	38	108	97	175
50A	2"	50	124	106	190
65A	2-1/2"	65	163	122	220
80A	3"	80	185	133	250
100A	4"	100	225	162	320



Male Screw Lever Handle (KS Head Valves)

0.98MPa(10kgf/cm³) Forged Brass Valve

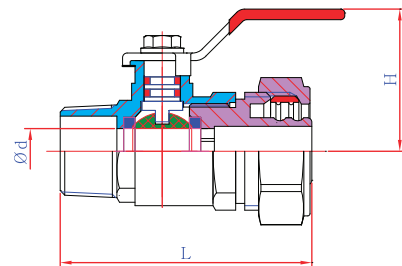

Size	Φd	L	t	H
15A	10	62.5	2.3	37.5

Connection Type :
Out-Polyethylene Pipe Fitting

Male Screw Lever Handle (KS Head Valves)

0.98MPa(10kgf/cm³) Forged Brass Valve

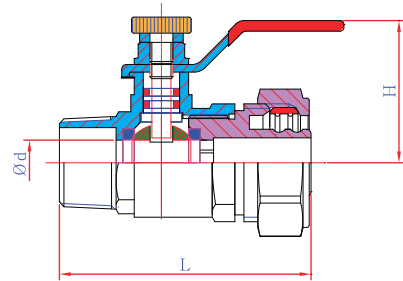

Size	Ød	L	t	H
15A	10	62.5	2.3	37.5

Connection Type : Polyethylene Pipe

Male Screw Butterfly Handle (KS Head Valves)

0.98MPa(10kgf/cm³) Forged Brass Valve

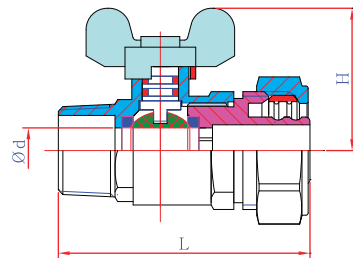

Size	Ød	L	t	H
12A	10	62.5	2.3	37.5
15A	10	62.5	2.3	37.5

Connection Type : Polyethylene Pipe

Other Valves 1

0.98MPa(10kgf/cm³) Forged Brass Valve

Nipple Valve

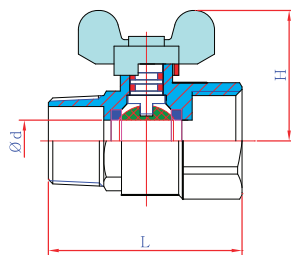

Size	Ød	L	t	H
15A	10	53	2	31.4

Socket Valve

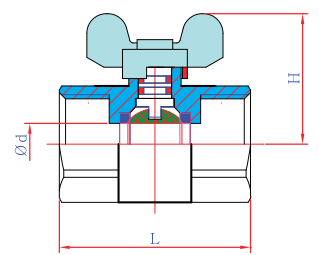

Size	Ød	L	t	H
15A	10	46	2	31.4



Other Valves 2

● Drain Header Valve

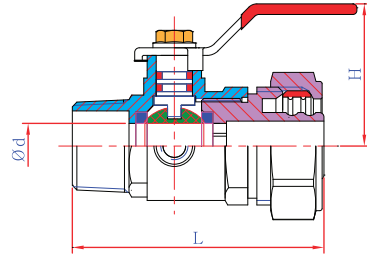

Size	ϕd	L	t	H
12A	10	58.5	2	31.4
15A	10	57	2	31.4

● Drain Air Valve

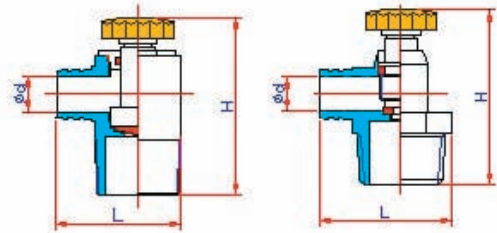

Size	ϕd	L	H
15A(S)	8	31.5	40
15A(L)	8	31.4	414

● PPC Header Valve

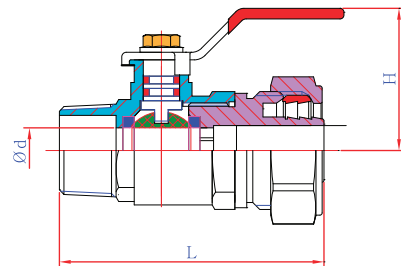

Size	ϕd	L	t	H
15A	14.5	70	2.3	37

 Other Valves 3

0.98MPa(10kgf/cm³) Forged Brass Valve

 Header Valve(M)

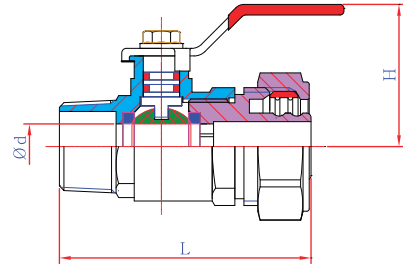

Size	Ød	L	t	H
12A	10	58.5	2	31.4
15A	10	57	2	31.4

Connection Type : Polyethylene Pipe
Handle Type : Butterfly & Lever Handle

 F Header Valve(X-L, Flexible Pipe)

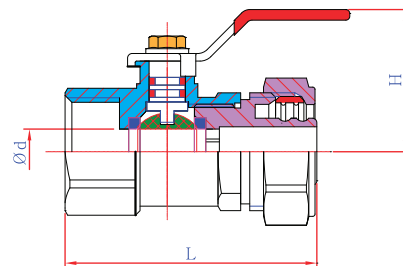
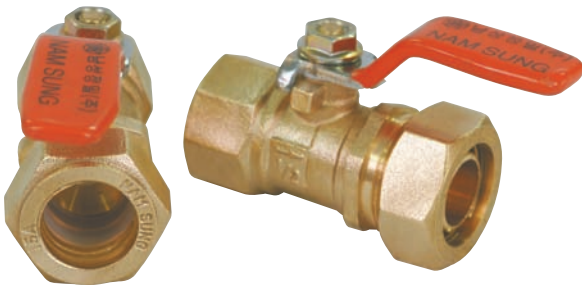

Size	Ød	L	t	H
15A	10	56.5	2	31.4

Connection Type : Polyethylene, Flexible Pipe
Handle Type : Lever Handle

 Coupling Valve

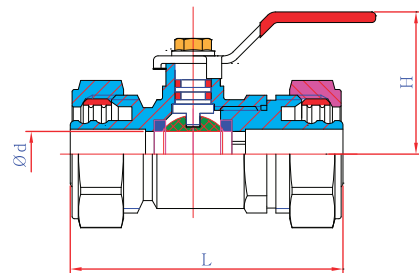
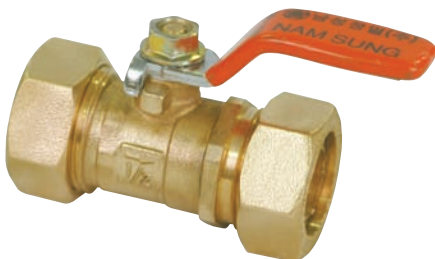

Size	Ød	L	t	H
15A(S)	10	60.15	2.2	31.4
15A(L)	10.5	72	3.2	40
20A	14.5	73	2.4	40

Connection Type : Polyethylene, Composite Pressure Pipe